









5450		PROFILI QUOTATI					
		I_x (cm ⁴)	I_y (cm ⁴)	E.Ix (GN.mm ²)	E.Iy (GN.mm ²)		
		5450	53,80	17,24	1,56	0,50	3 ...

5207	
14 x 34,6	4,3 x 16

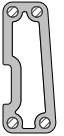
	S (mm)	/
	I_x, Fe_{eq} (cm ⁴)	0,59
	I_y, Fe_{eq} (cm ⁴)	0,04
	E.Ix (GN.mm ²)	1,25
	E.Iy (GN.mm ²)	0,09

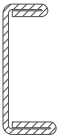
3477	
14,1 x 34,5	3,9 x 13

	S (mm)	1,5
	I_x (cm ⁴)	2,03
	I_y (cm ⁴)	0,19
	E.Ix (GN.mm ²)	/
	E.Iy (GN.mm ²)	/

3476	
32,6 x 8,4	3,9 x 13

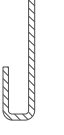
	S (mm)	1,5
	I_x (cm ⁴)	0,07
	I_y (cm ⁴)	0,68
	E.Ix (GN.mm ²)	/
	E.Iy (GN.mm ²)	/

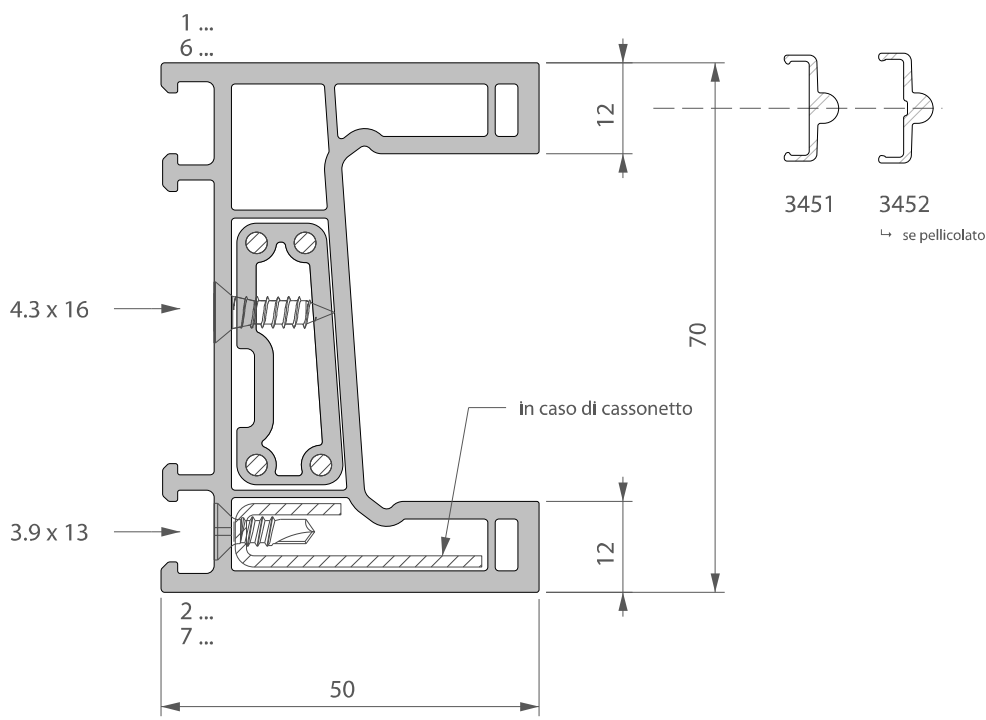

Accessori

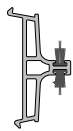

5485



3451



3452



3434

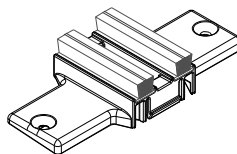



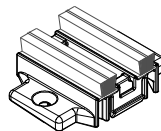

5475

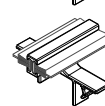
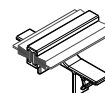
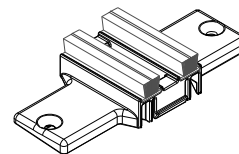

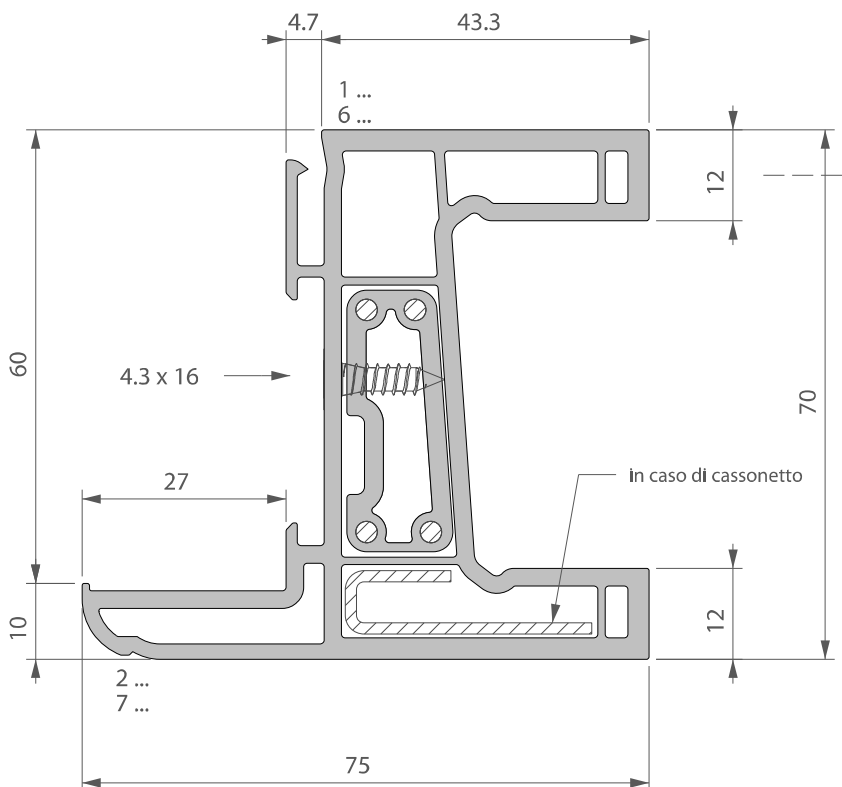
5476

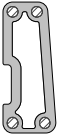
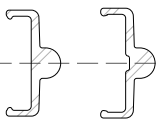

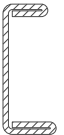
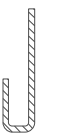
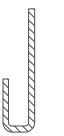
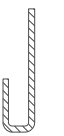
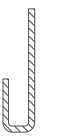
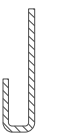
5457		PROFILI QUOTATI					
		I_x (cm ⁴)	I_y (cm ⁴)	E.I_x (GN.mm ²)	E.I_y (GN.mm ²)		
	5457	61,63	30,98	1,79	0,50	3 ...	8 ...
5207							
 14 x 34,6 4,3 x 16							
	S (mm)	/					
	I_x , Fe_{eq} (cm ⁴)	0,59					
	I_y , Fe_{eq} (cm ⁴)	0,04					
	E.I_x (GN.mm ²)	1,25					
	E.I_y (GN.mm ²)	0,09					
3477		 14,1 x 34,5 3,9 x 13					
							
	S (mm)	1,5					
	I_x (cm ⁴)	2,03					
	I_y (cm ⁴)	0,19					
	E.I_x (GN.mm ²)	/					
	E.I_y (GN.mm ²)	/					
3476		OPZIONALE					
32,6 x 8,4							
	S (mm)	1,5					
	I_x (cm ⁴)	0,07					
	I_y (cm ⁴)	0,68					
	E.I_x (GN.mm ²)	/					
	E.I_y (GN.mm ²)	/					

Accessori

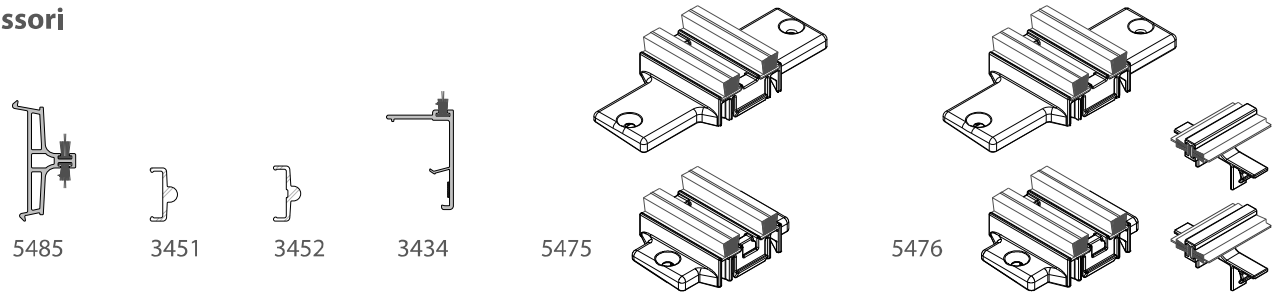

5459		PROFILI QUOTATI					
		I_x (cm ⁴)	I_y (cm ⁴)	E.Ix (GN.mm ²)	E.Iy (GN.mm ²)		
		5459	64,79	45,57	1,88	1,32	3 ...

5207		PROFILI QUOTATI					
		I_x (cm ⁴)	I_y (cm ⁴)	E.Ix (GN.mm ²)	E.Iy (GN.mm ²)		
		5207	0,59	0,04	1,25	0,09	1 ...

3477		PROFILI QUOTATI					
		I_x (cm ⁴)	I_y (cm ⁴)	E.Ix (GN.mm ²)	E.Iy (GN.mm ²)		
		3477	2,03	0,19	/	/	2 ...

3476		PROFILI QUOTATI					
		I_x (cm ⁴)	I_y (cm ⁴)	E.Ix (GN.mm ²)	E.Iy (GN.mm ²)		
		3476	0,07	0,68	/	/	2 ...

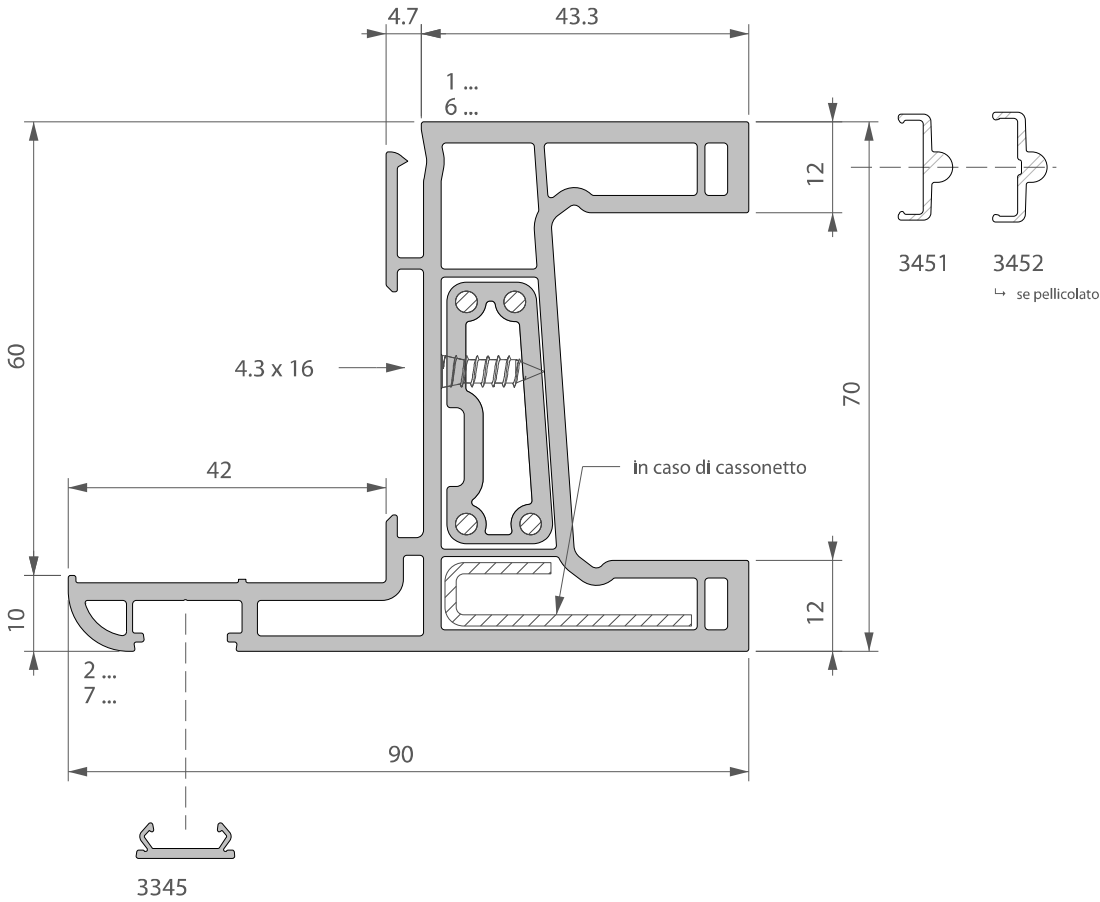

Accessori

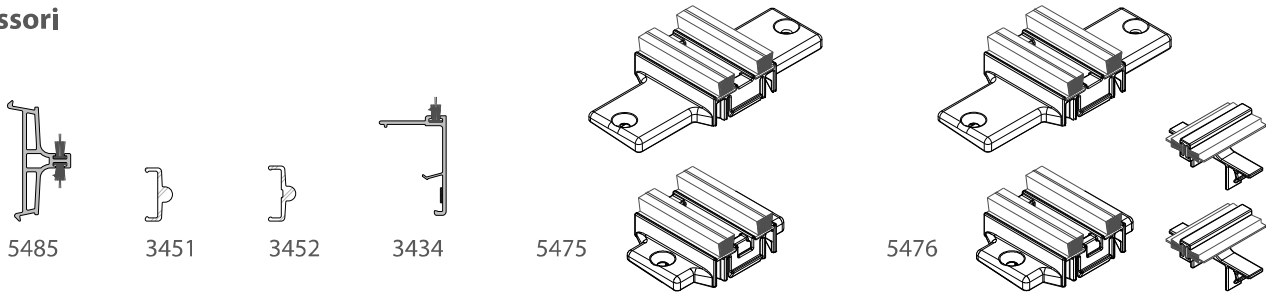

5450 - 5460

SEZIONI

